

Let's Be Safe Out and About



Photocopiable Worksheets

Road Safety

Curriculum subjects covered by
'Big Book' and Activity Sheets.

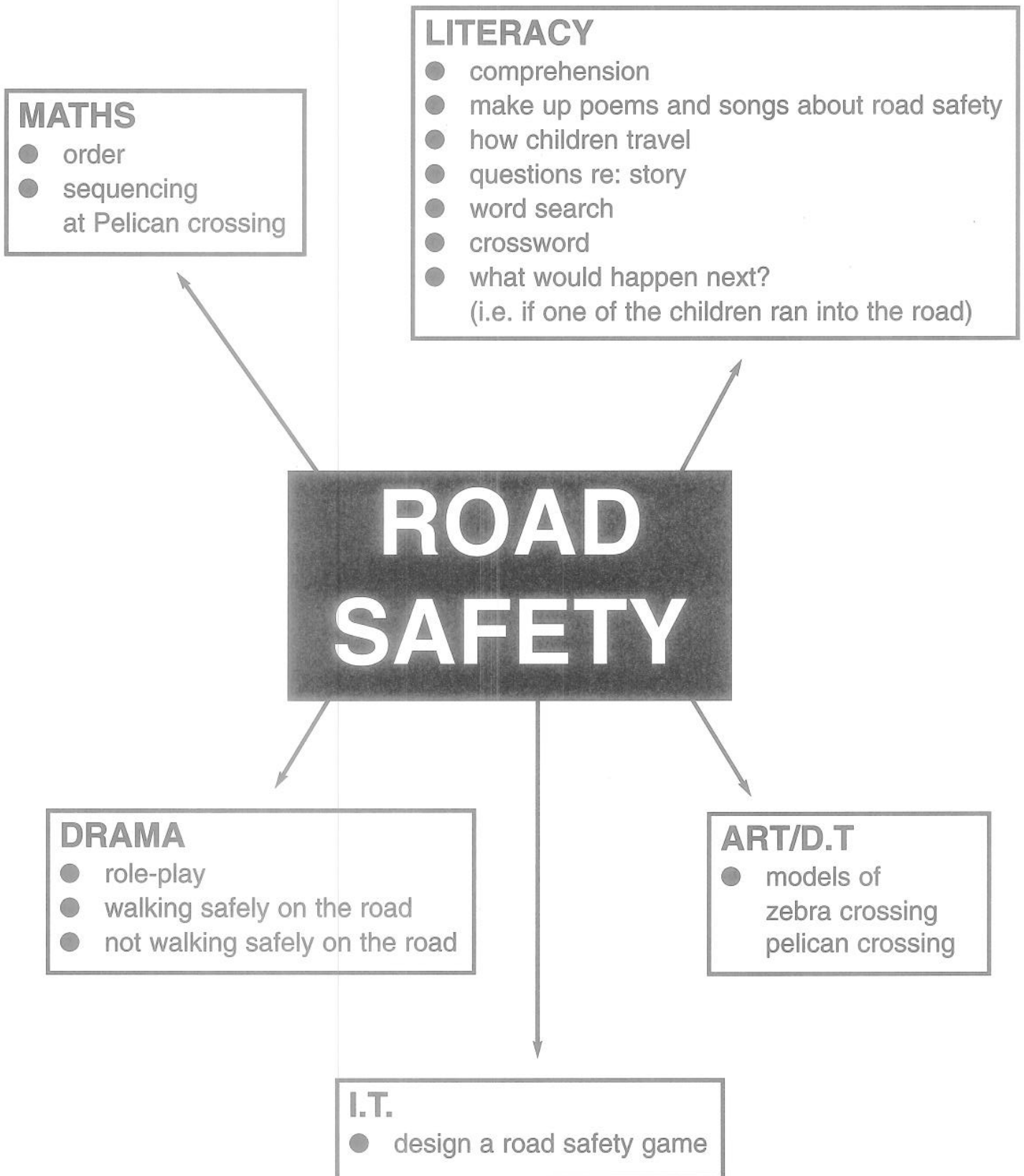



Getting ready to go out

When I take things to play with outside, I should carry them ...

(tick ✓ the box)



under my arm



in my hand



in a bag

When I am walking along the pavement I should ...

(tick ✓ the box)

walk by myself

hold hands with mum, dad or a grown-up I know well

List and draw 4 different toys you may take to play with in the park
(ask your teacher to help)



Out and about in the street

Colour this picture.

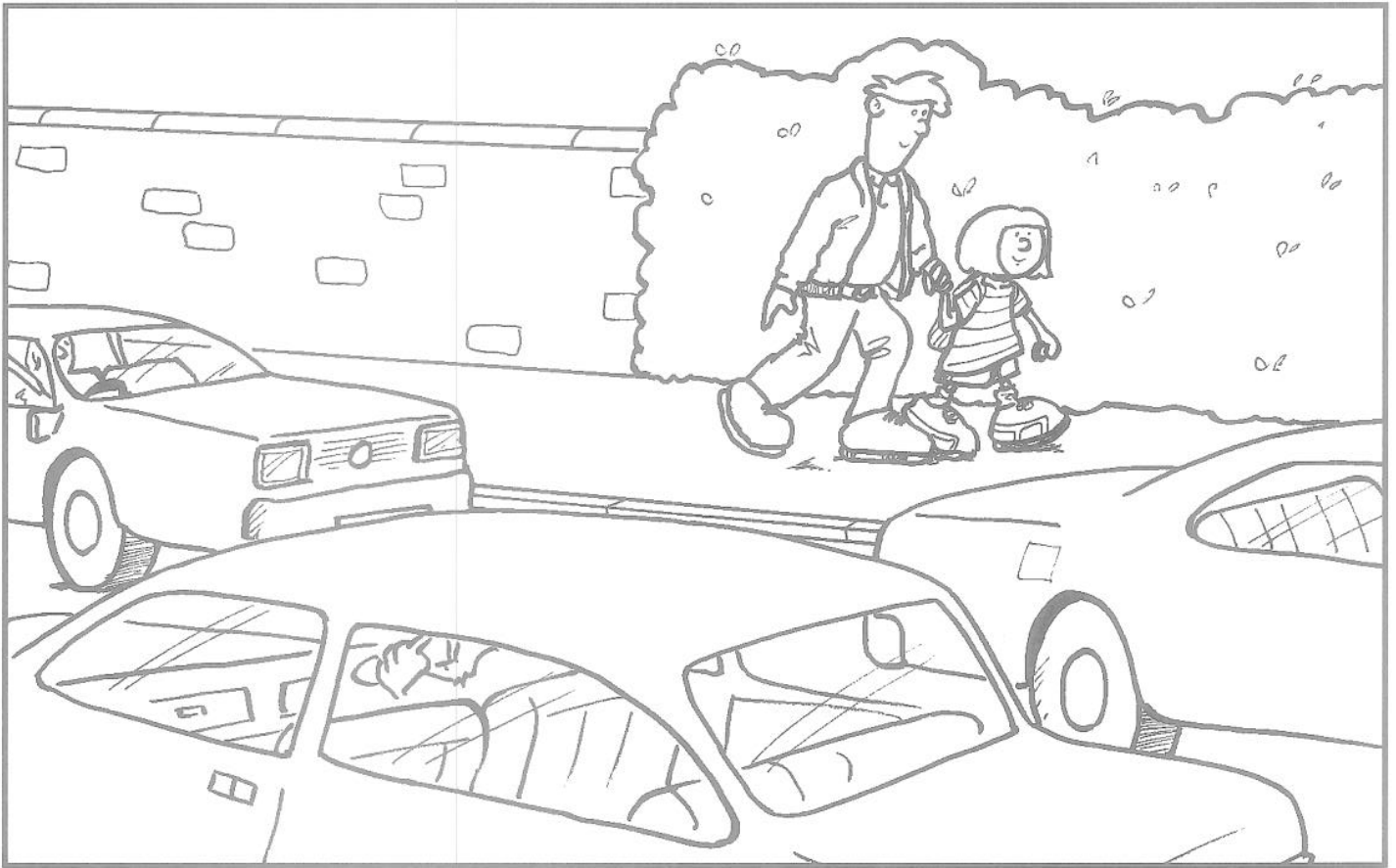

Put the right words into the sentences

walk **hands** **near**

pavement **kerb** **grown-up**

- 1) I always **w** _ _ _ on the inside of the **p** _ _ _ _ _ _ _ _ _ .
- 2) I do not walk **n** _ _ _ _ the **k** _ _ _ _ .
- 3) I always hold **h** _ _ _ _ _ with a **g** _ _ _ _ _ - **u** _ I know.



Danger by the road

Colour in and cut out the pictures (along the dotted lines) and paste them in the fast and slow boxes on worksheet 3(b)

Write the correct name under each vehicle

ambulance

motorbike

car

bicycle

lorry

milk float

tractor

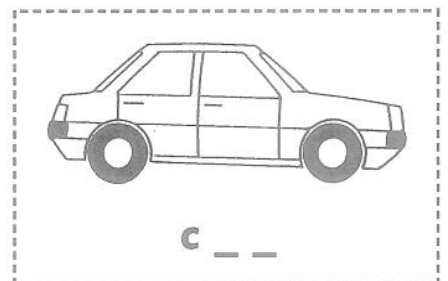
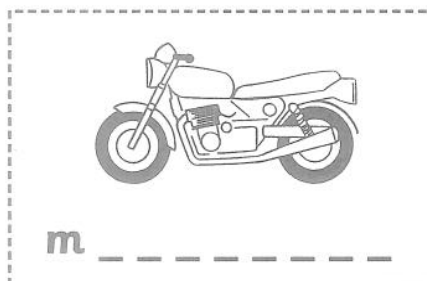
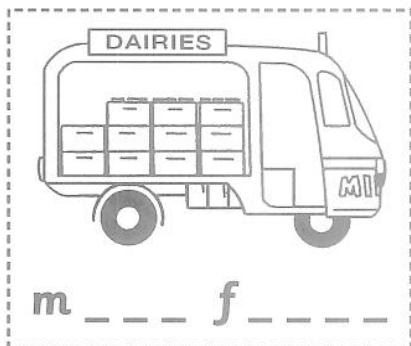
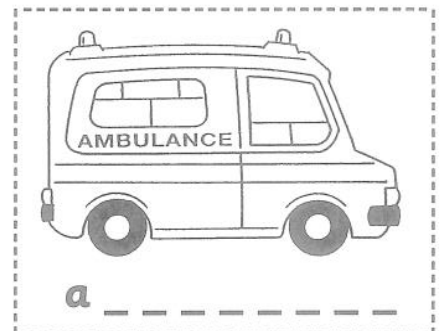
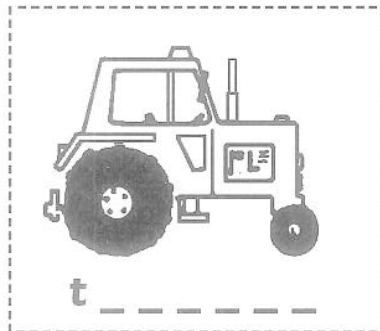
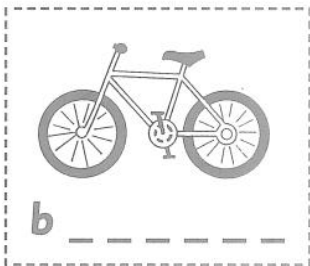
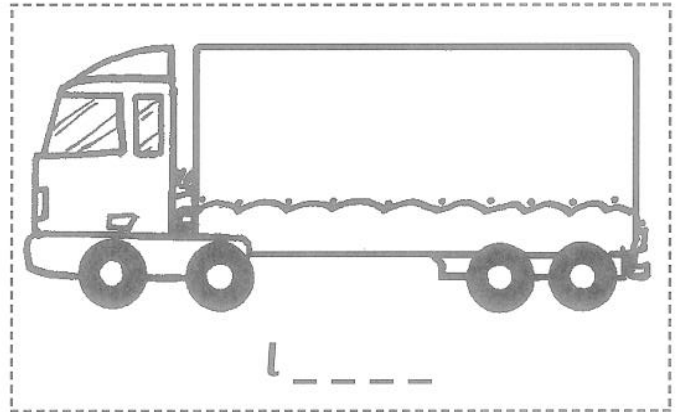



Danger by the road

fast

ambulance

motorbike

car

lorry

slow

bicycle

milk float

tractor



Crossing the road

Things to remember when crossing the road ...

Cut out the words on worksheet 4a and paste them in the right order on this sheet.

1

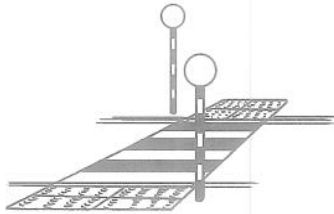

First,

2

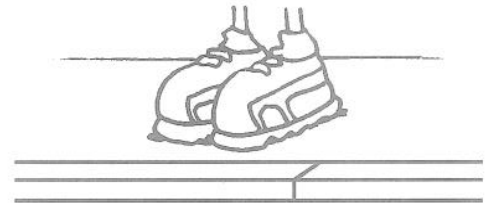

Stop

3



Lo & Li

4

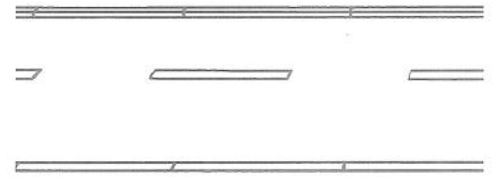

If

5

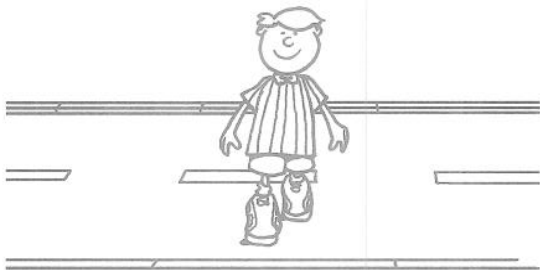

Walk

6

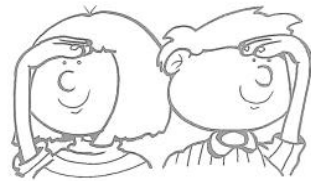

Keep lo

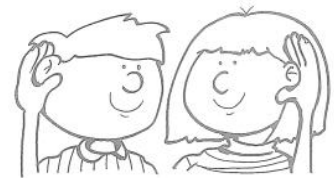

Keep li



Crossing the road

Cut out these words and paste them in the right order on worksheet 4.

Walk straight across the road

If no traffic is near

Stop at the kerb

Keep listening

Listen

Look

First, find a safe place to cross

Keep looking



In the park

Colour in and cut out these figures and stick them in the right place on each picture (find the pictures in the Big Book to help you).

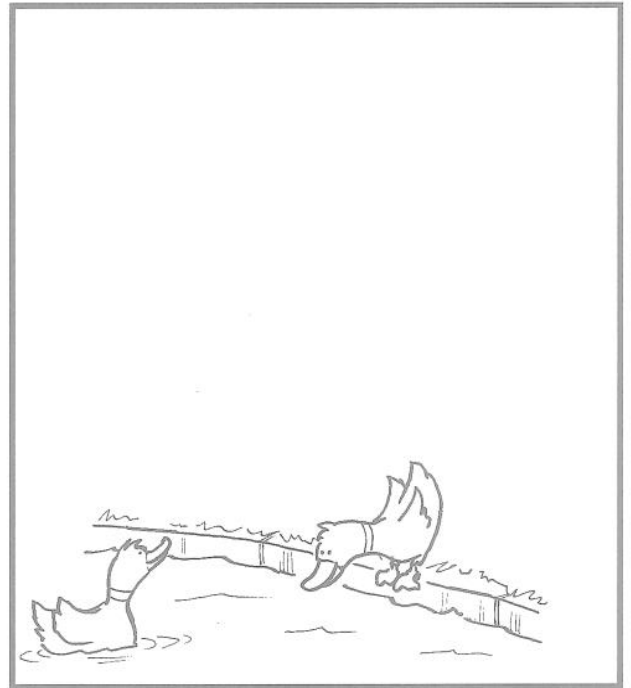
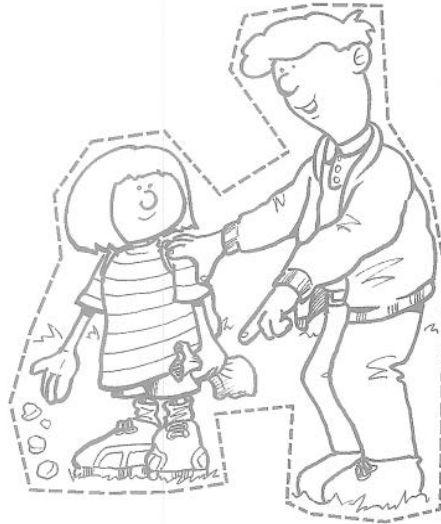

Keep away from water



When cycling in the park, keep on the cycle path.

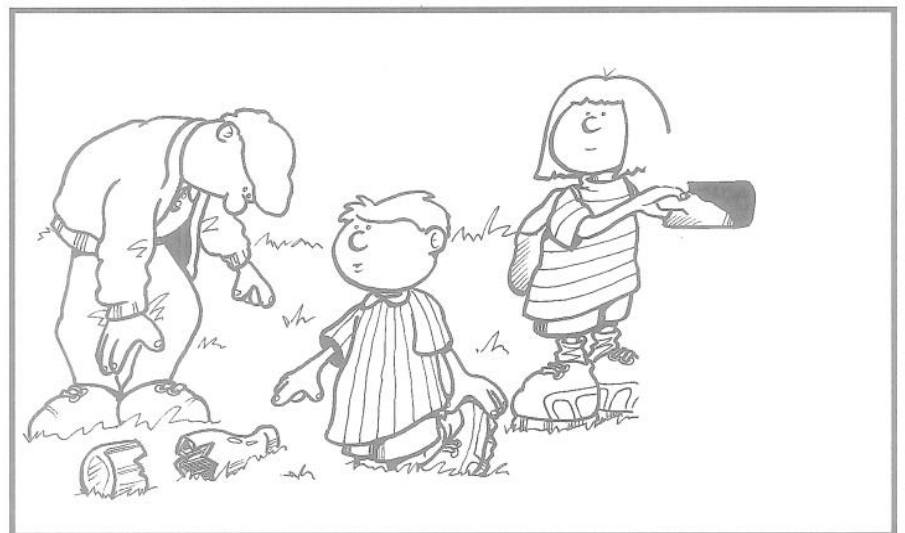

Put your litter in the litter bin.
You should not pick up anything
you find on the ground



Play Safely

Where should I play with my ball?

Find the right route to the safest place to play



A

B

C

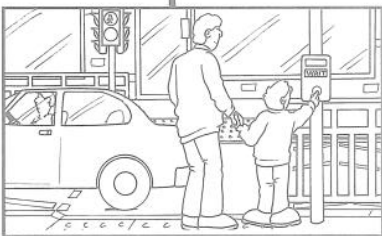
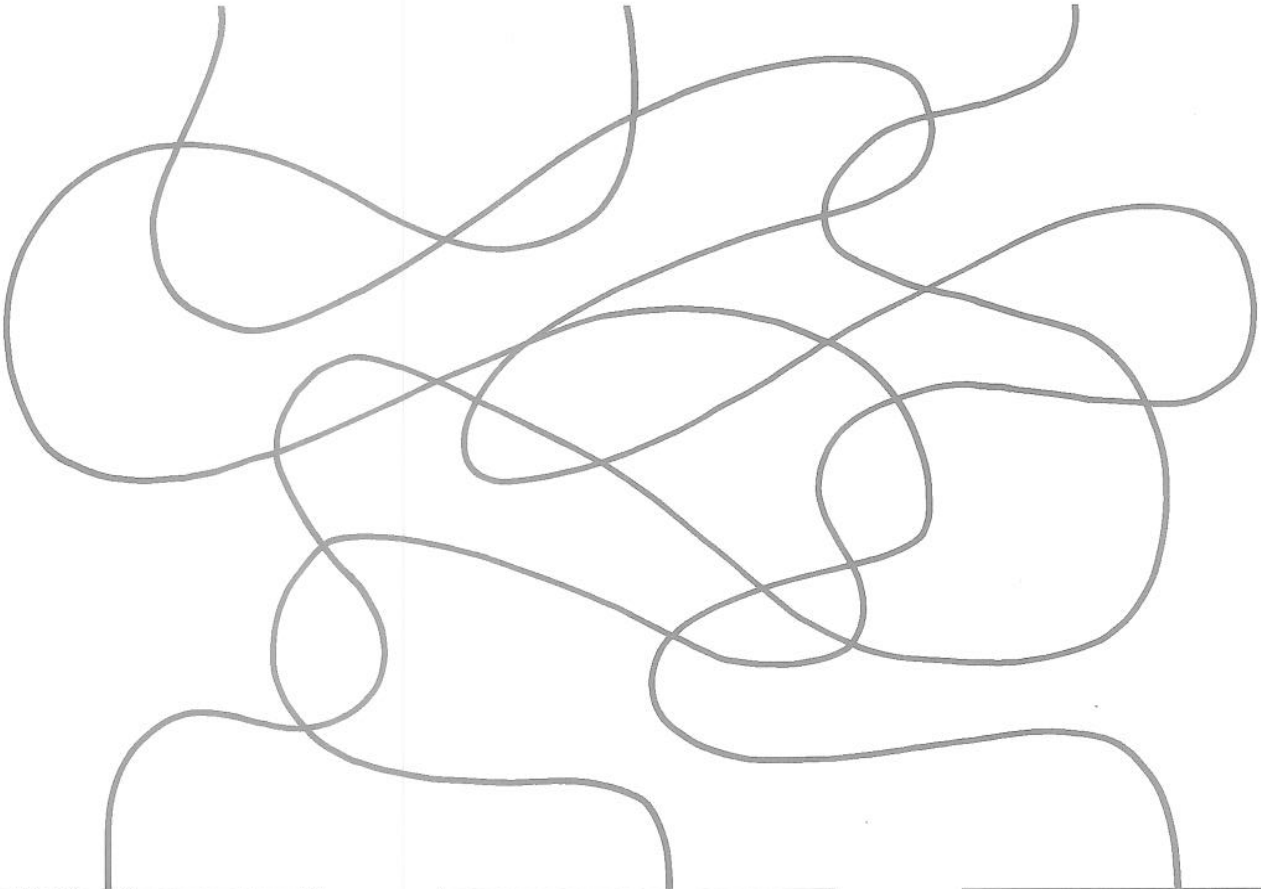



Going home

Look for the words on worksheets 7a/b.

Unscramble the letters **p i n a e l c**

to spell **p** _ _ _ _ _

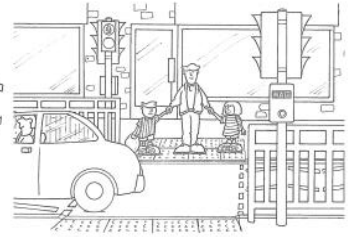

b k r e

Stop at the **k** _ _ _ _

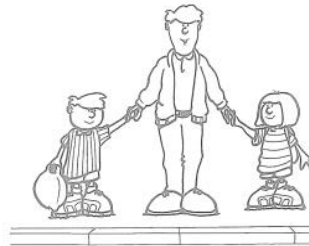

t t n o b u

Press the **b** _ _ _ _ _

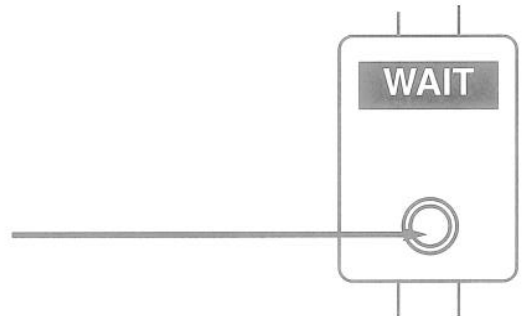

n e r e g

Wait until you see the **g** _ _ _ _ _ man



p o t s p e d

Make sure the traffic has

s _ _ _ _ _

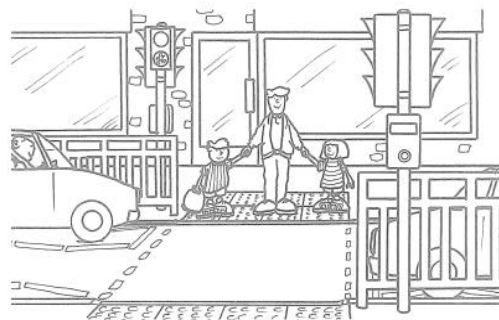

Cross the road and keep

k n g o o l i **l** _ _ _ _ _ and

l e n s t l g n i **l** _ _ _ _ _



Going home

Photocopy or paste these letters onto card and cut them out.
Practice spelling the words before filling in the missing words
on worksheet 7.

p	i	n	a	e
----------	----------	----------	----------	----------

l	c	b	k	r
----------	----------	----------	----------	----------

e	t	t	n	o
----------	----------	----------	----------	----------

b	u	n	e	r
----------	----------	----------	----------	----------

l	g	n	i	e
----------	----------	----------	----------	----------



Going home

Photocopy or paste these letters onto card and cut them out.
Practice spelling the words before filling in the missing words
on worksheet 7.

g

p

o

t

s

p

e

d

k

n

g

o

o

l

i

l

e

n

s

t



Make a road (a)

Photocopy or paste onto card, and cut out the following sheets to create your own road network and crossings

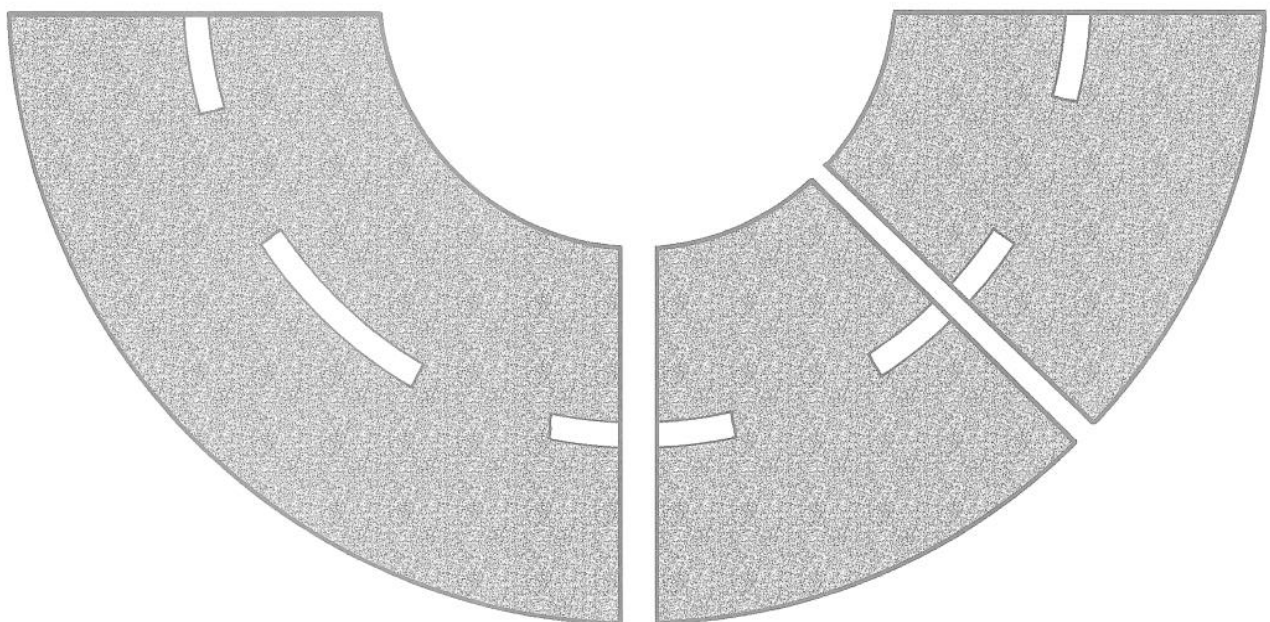
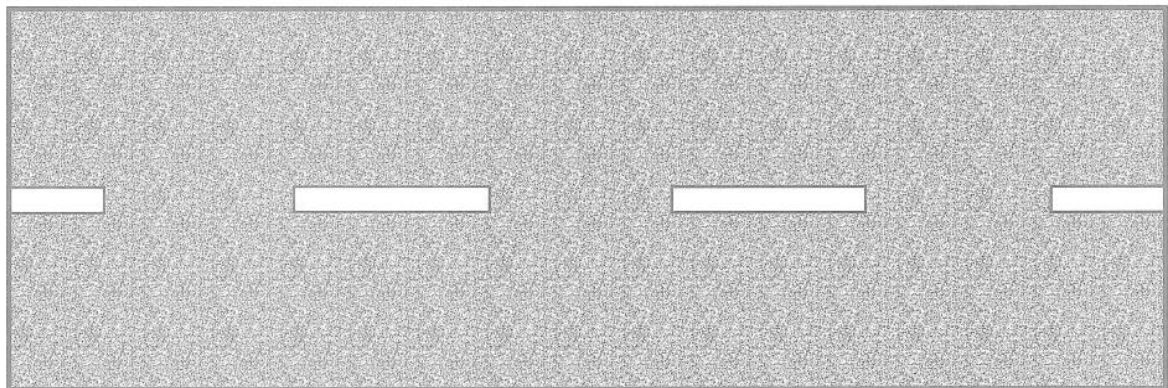
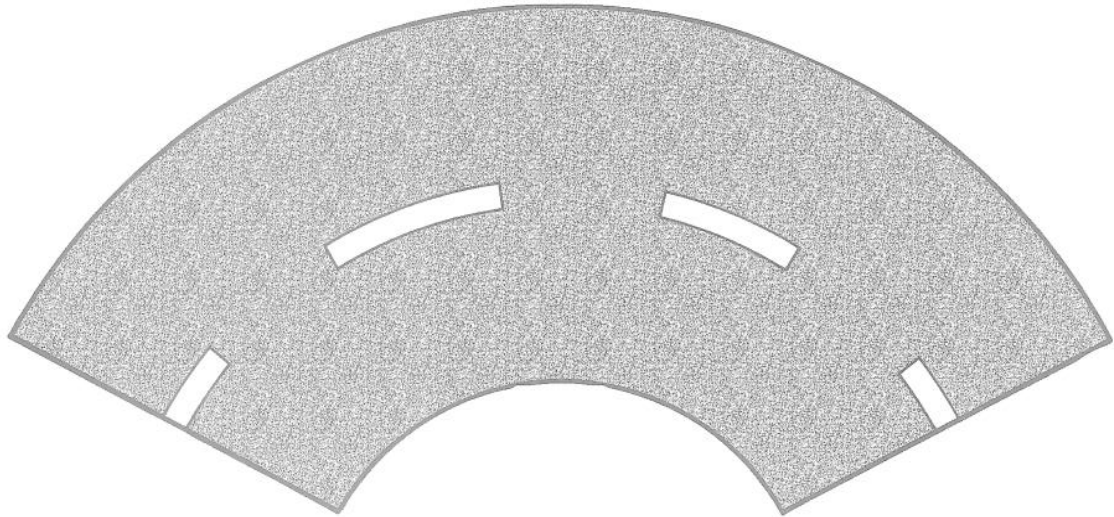



Let's Be Safe - Out and About

Make a road (b)

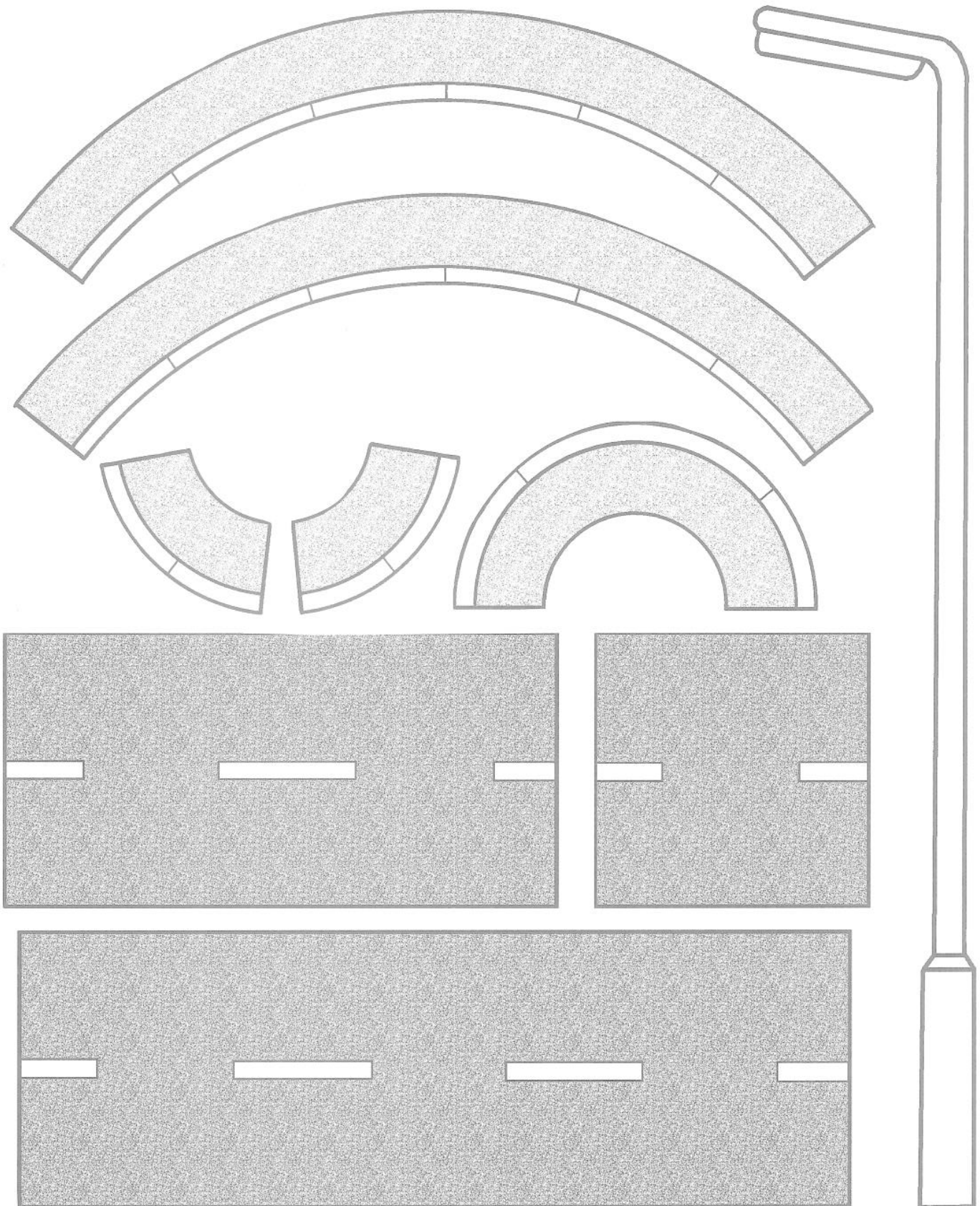

Why not draw some houses and pedestrians to go with your road layout.



Let's Be Safe - Out and About

Make a road (c)

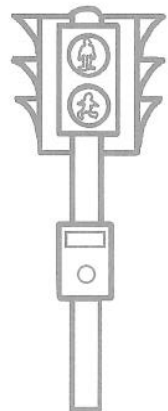
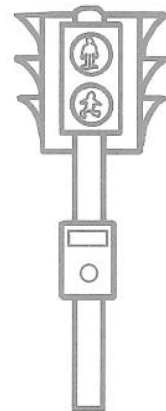
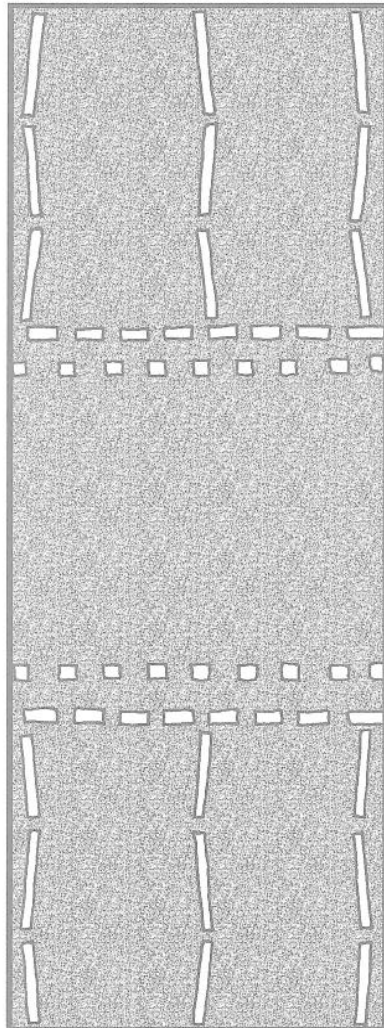
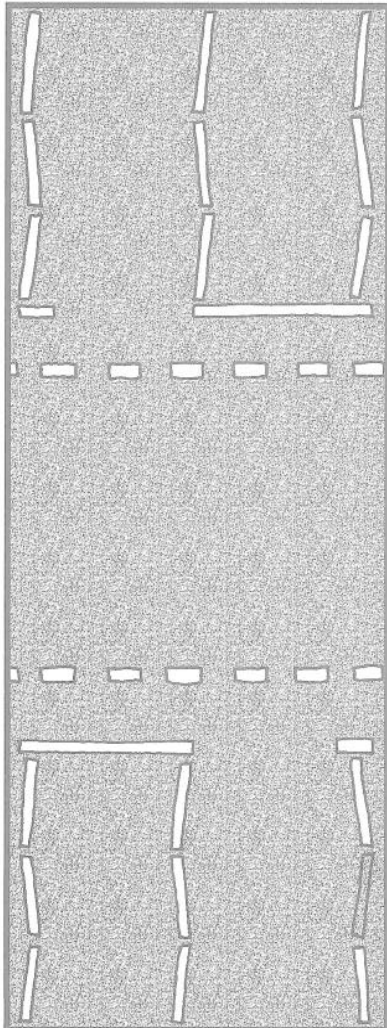
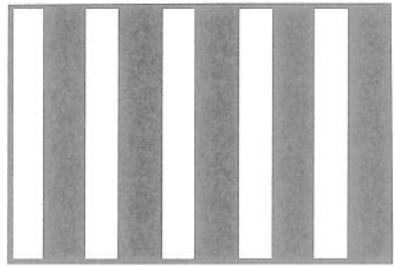
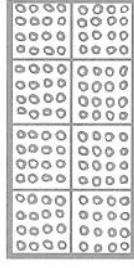
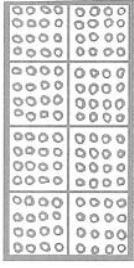
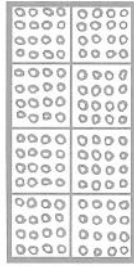
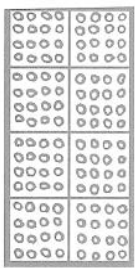
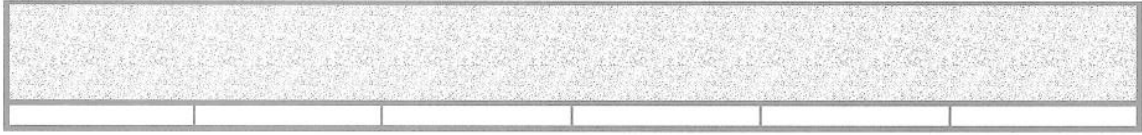



Let's Be Safe - Out and About

Make a road (d)

Photocopy or paste onto card, colour in, and cut out these vehicles to complete your road

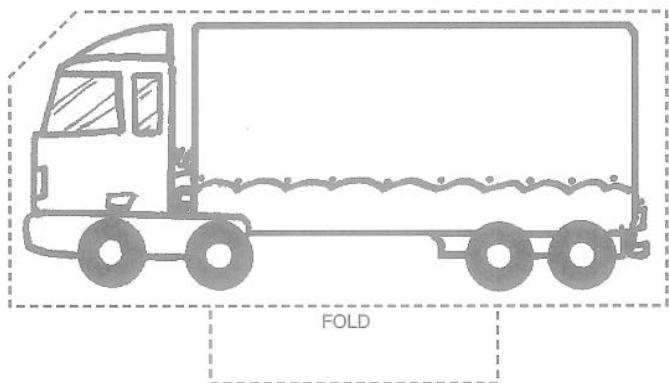

Fold the tab under to help the vehicle stand up.

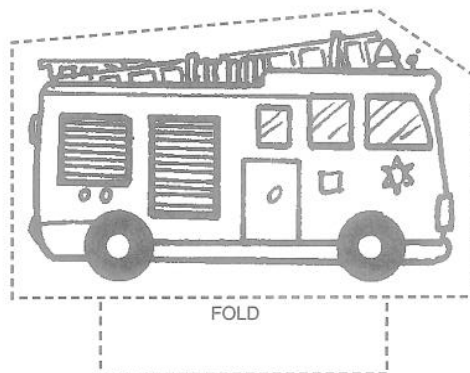
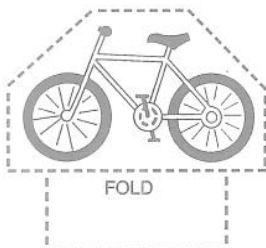
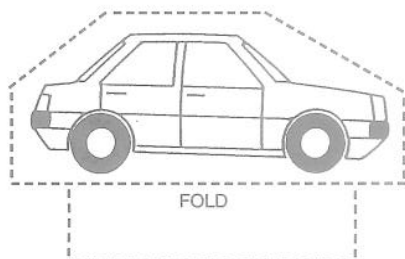
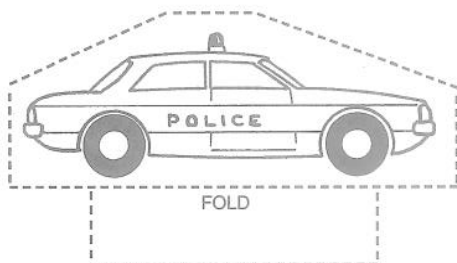
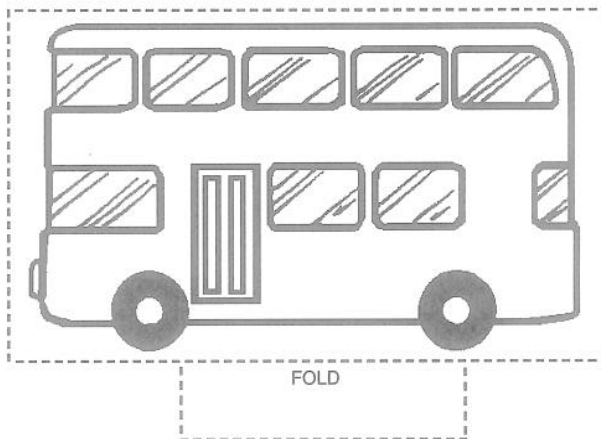
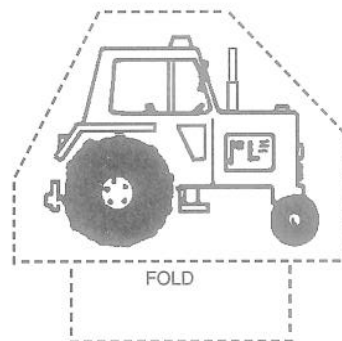
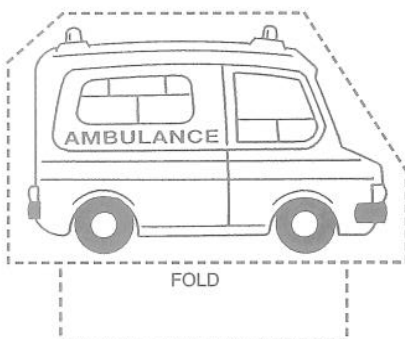
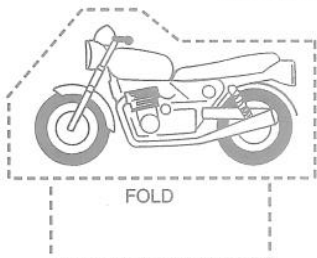



Play Safe Game

Can you get to the park safely from home?

✓ The tick means this is the right thing to do.

✗ The cross means this is the wrong thing to do.

Photocopy or paste the sheet onto some thin card.

Cut out and assemble the spinner.

Place half a cocktail stick through the centre of the spinner.



Finish

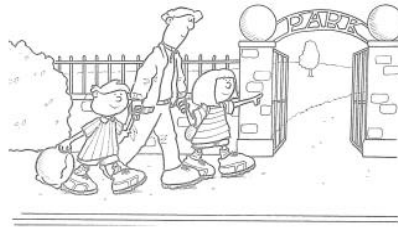

10

9

At the kerb, hold hands, stop, look and listen. Move to finish. ✓

6

7

8

You play near the water and nearly fall in. Miss a turn. ✗

5

Find a safe place to cross. Pelican crossing. Go forward 1 place. ✓

4

Colour in the counters and cut them out.



3

You let go of mum or dad's hand. Go back to park and start again. ✗

2

Put the ball in the bag before you set off from home. Go forward 2 places. ✓

1

Start

